

FC-757AT
INSTRUCTION
MANUAL

YAESU MUSEN CO., LTD.

C.P.O. BOX 1500

TOKYO, JAPAN

THE FC-757AT FULLY AUTOMATIC HF ANTENNA TUNER



The FC-757AT is a multi-functional microprocessor-controlled RF handling device designed to provide for all of the antenna switching, impedance matching and RF metering requirements of an amateur station, with maximum power handling capability of 150 watts.

Designed to match the FT-757GX All Mode HF Transceiver, which provides automatic band-switching and power control functions via the supplied control cable, the FC-757AT can also be automatically controlled by the FT-980 Transceiver via an optional control cable. Manual power and bandswitching controls are also provided for use when the FC-757AT is powered by an independent DC source and used with any other HF transceiver, transmitter or receiver.

The 8-bit microprocessor allows for fast, accurate automatic impedance matching utilizing a modified pi-L network. A directional CM coupler at the transmitter side of the network and an RF pickup at the antenna side ensure a wide range of SWR acceptance, and final SWR to the transmitter better than 1.5:1 for impedances in that range. Manual matching is also possible for particularly difficult situations, or when matching for receiving only.

Two antenna jacks are provided, along with controls for remote automatic and manual selection of up to five antennas in total when the FC-757AT is used with the optional FAS-1-4R Remote Antenna Selector. An internal 50-ohm dummy load is included in the FC-757AT, along with an in-line RF wattmeter and a self-calculating (automatic) SWR meter.

The particular antenna selected for operation on a particular band, along with the settings of the matching network, are digitally encoded and stored in lithium-backed RAM by the microprocessor, so that when that band is selected again, the same antenna and matching settings are automatically reset quickly. Thus no extra time is required for rematching.

During operation, any change in frequency that causes the SWR to rise above 1.5:1 will cause the auto-tune system to automatically rematch the load if desired, and the new settings will then be automatically written into memory for that band.

Please read this manual carefully before operating your FC-757AT, to ensure optimum performance and enjoyment of its many features.

SPECIFICATIONS

MATCHING SECTION

Frequency range (TX, w/auto band select):

- 1.8 – 2.0 MHz
- 3.5 – 4.0 MHz
- 7.0 – 7.5 MHz
- 10.0 – 10.5 MHz
- 14.0 – 14.5 MHz
- 18.0 – 18.5 MHz
- 21.0 – 21.5 MHz
- 24.5 – 25.0 MHz
- 28.0 – 29.9 MHz

Input impedance:

50Ω

Output impedance range:

- 10 – 250Ω
- 25 – 100Ω (1.8 – 2.0 MHz)

Maximum RF power:

150W

Insertion loss:

less than 0.5 dB

Motor stop SWR:

1.5:1 or better

SWR meter scale range:

1:1 – 3:1

In-line power meter ranges:

15W, 150W f/s

DUMMY LOAD

Impedance:

50Ω

Power dissipation:

100W CW (less than 30 sec.)

POWER REQUIREMENTS

Supply voltage:

13.5V DC ±10%

Current:

300 mA max.
(400 mA w/FAS-1-4R)

Size:

(W) 238 x (H) 94 x (D) 241 mm

Weight:

Approximately 3.7 kg

Specifications subject to change without notice or obligation

Supplied Accessories

| | | |
|--------------------------------|-------------|---|
| Connection Cable A | (T9100160A) | 1 |
| 5D-2V Coax w/type M connectors | | |
| Connection Cable B | (T9015099) | 1 |
| Control Cable C for FT-757GX | (T9101292) | 1 |

Optional Accessories

| | | |
|-----------------------------------|------------|---|
| Control Cable for FT-980 | (D4000014) | 1 |
| FAS-1-4R Remote Antenna Connector | (D3000198) | 1 |

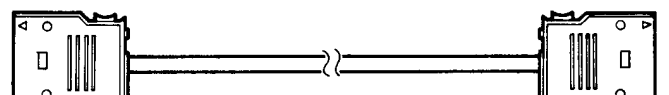
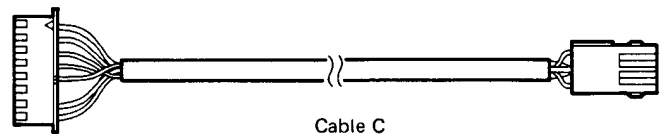
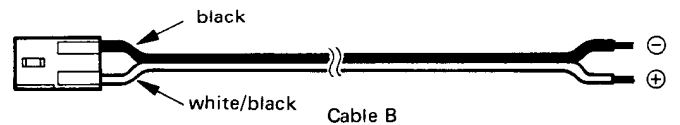
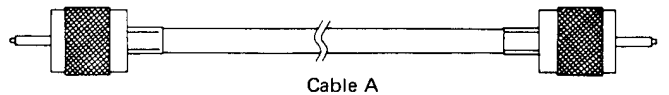

FRONT PANEL CONTROLS

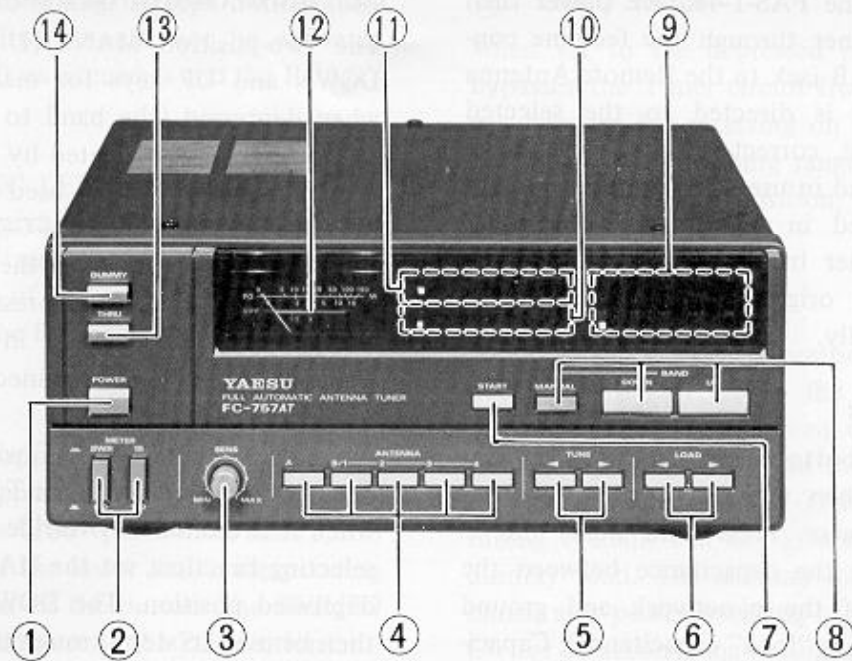

① POWER Switch

When this switch is set to the off (out) position, the RF INPUT jack is connected directly to the ANT A jack, and the Tuner is removed from the circuit. However, tuner settings (and antenna selections) stored in the memory are retained by the internal lithium battery memory backup.

If the FC-757AT is used with a transceiver designed to control the tuner automatically, such as the FT-757GX or FT-980, power to the Tuner is switched automatically via the interconnecting control cable. In this case, the POWER switch on the FC-757AT can be left in the on (depressed) position, and the on/off function will be performed by the transceiver POWER switch.

② METER Switches (SWR/PO and 15/150)

These two-position switches select the function and full scale RF power range of the meter. In the PO (out) position, the SWR/PO switch causes the meter to indicate forward power output in watts, with the 15/150 switch position determining the related meter range.

In the SWR (depressed) position, the SWR/PO switch activates the self-calculating SWR system, which indicates SWR on the (lower) meter scale when the 15/150 switch is set to the correct position corresponding to the amount of RF power applied from the transmitter (if at least 10–15 watts).

③ SENSitivity Control

This potentiometer adjusts the SWR threshold level at which the automatic tuning system automatically starts and stops its tuning procedure. If the SWR of the antenna system is close to 1.5:1, this control should be set fully clockwise for maximum sensitivity to SWR. However, if the SWR is high, the SWR null may be too sharp for the automatic sensing circuitry to notice, in which case the SENS control must be set further counterclockwise.

For manual tuning and mobile operation or other conditions where the SWR continually fluctuates, the SENS control should be set fully counterclockwise. Also, once auto-tuning has been completed and the tuner settings are to be retained in memory, set this control fully counterclockwise.

④ ANTENNA Buttons

These five momentary contact buttons are used to select antennas. The first button (A) at the left will select the ANT A jack on the rear panel. This is also the default condition, and thus this selection is made automatically while power is off.

Ordinarily, any of the four remaining buttons will select the antenna connected to the ANT B jack on the rear panel. However, when the FC-757AT is used with the FAS-1-4R Remote Antenna Selector, each of these buttons will select, via the interconnecting control cable, one of the four jacks

selector, where it is directed to the selected antenna. Once the correct antenna has been selected for the band in use, this antenna selection data will be stored in memory, so that after

when depressed (the band to which the tuner is set to operate is indicated by the ten LEDs above these buttons). When used with a transceiver designed to control the FC-757AT, such as the

fully counterclockwise. Press (and hold) the ◀ button to increase the capacitance between the output terminal of the pi-network and ground (usually referred to as "load" capacitance). Capacitance will increase to maximum (290 pF) and stop. Push the ▶ button to decrease capacitance to minimum. The optimum value of capacitance set by these buttons must be determined by watching the meter (set for PO), and tuning for maximum forward power. The capacitance set manually will be stored in the memory for that band.

when it is desired to override the automatic band-selecting function, set the MANUAL button to the depressed position. The DOWN and UP keys can then be used to step through the bands.

Note that the tuner settings are automatically stored in memory on each band, so that when the Tuner is reset to a band previously used, the variable capacitors and antenna select relays will automatically reset to the positions to which they were set when last operating on that band.

When automatic band selection by the transceiver is used to select the 1.8 MHz band, the Tuner will automatically be set to the 1.8L band position. However, if the Tuner is unable to find the dip in SWR, it may be necessary to press the MANUAL button, and then the UP key, to switch to the 1.8H band position.

⑥ LOAD Buttons

These two push buttons are used for manual antenna tuning, along with the TUNE buttons, when the SENS control is set fully counterclockwise. The manner of operation is the same as for the TUNE buttons, but the capacitance which is adjusted by the LOAD buttons is actually the capacitance in series with the load at the output of the tuner, up to a maximum of 430 pF. The capacitance set manually will be stored in memory for that band.

⑨ Band Indicators

One of these ten green LEDs will be lit to indicate the selected MHz band to which the FC-757AT is set.

⑦ START Button

This momentary contact button activates the auto-tune system manually. Normally, when the operating band is changed, the Tuner will automatically adjust itself for the same antenna selection and matching impedance set the last time that band was used. Press the START button to retune if SWR is now too high. Manual restart, caused by pressing this button, can be used to force the auto-tune system to retune at any time.

⑩ Antenna Selection Indicators

One of these five LEDs will be lit to indicate which antenna is selected for operation. The ANT A LED is green, and the others are yellow.

⑪ Tuner Status Indicators (READY, WAIT and WARNING)

The green READY LED is lit whenever it is alright to transmit. The yellow WAIT LED lights after changing bands while the Tuner is resetting the

and also during auto-tuning. Except during auto-tuning, the transmitter should not be activated until the WAIT LED extinguishes and the READY LED lights.

If the red WARNING LED lights during transmission, a severe mismatch is present at the selected antenna jack. Stop transmitting immediately, and check for the cause of the problem (such as open or short circuits in the feedline).

12 Meter

The meter indicates approximate RF output power in watts on the upper scale, with the top half corresponding to the "150" position of the 15/150 METER button, and the lower half corresponding to the "15" position of the button (the SWR/PO METER button must be set to the PO position).

The lower scale of the meter indicates antenna SWR during transmission, when the SWR/PO METER button is set to the SWR (depressed) position. This SWR indication is calculated automatically by the internal circuitry, and is therefore fairly independent of the actual RF power applied to the tuner by the transmitter, as long as it is at least 10–15 watts.

13 THRU Switch

When set to the depressed position, this switch bypasses the Tuner circuit from the RF line. This can be used for receiving on frequencies that are outside of the matching range of the FC-757AT. In the undepressed position, the Tuner is in the RF line.

14 DUMMY Switch

When in the depressed position, this switch connects the INPUT from the transmitter to the internal dummy load, leaving only the CM coupler for the metering system in the circuit. Therefore, the antenna selection and THRU switches, and the tuning system, will not affect operation into the dummy load. The dummy load impedance is 50 ohms, and power handling capability is 100 watts CW for 30 seconds maximum, after which it should be allowed to cool for one minute. The DUMMY switch must be in the undepressed position to use the tuning system or to deliver power to the antenna.



REAR PANEL CONNECTIONS

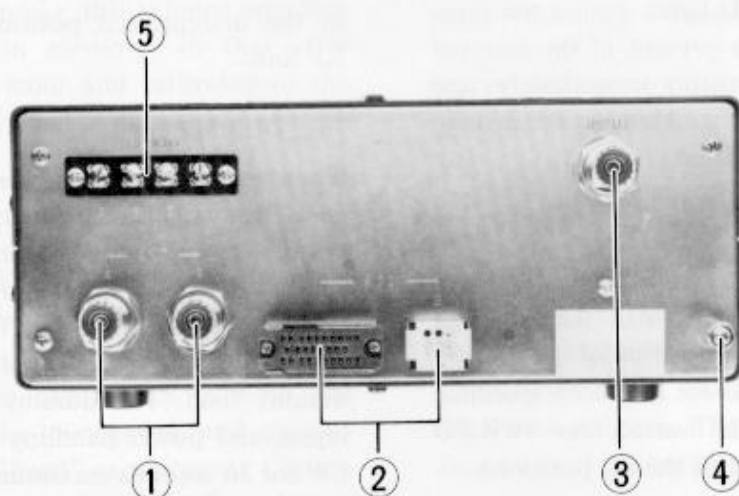

① ANT A, B

These type M coaxial jacks are for connection of the antenna system(s). The ANT A jack is automatically selected when the DC power to the Tuner is switched off, or when the front panel POWER switch is off. The ANT B jack is for connection of an alternate or secondary antenna system, or for the feedline to the optional FAS-1-4R Remote Antenna Selector.

② ACC 1, 2

The blue 28-pin ACC 1 connector accepts power and band selection signals from the FT-980 Transceiver via the optional interconnecting cable.

The white molex ACC 2 connector accepts power and band selection signal from the FT-757GX Transceiver via supplied interconnecting cable C. When the FC-757AT is used with a transceiver that is not designed for automatic band control, DC power must be supplied to this connection via supplied DC power cable B. Power requirements are 12 to 15V at 300 mA, or 400 mA if the FAS-1-4R is also used.

③ INPUT

This type M coaxial jack is for connection to the antenna jack on the transceiver, via supplied connection cable A. RF power applied here should be limited to about 150 watts, or 100 watts when the internal dummy load is selected.

④ GND Binding Post

For optimum performance and safety, connect this terminal to a good earth ground by the shortest path possible, using heavy braided cable.

⑤ REMOTE Terminal Strip

These terminals provide the antenna selecting signals for the FAS-1-4R when the appropriate control cable is connected here.

INSTALLATION

ANTENNA CONSIDERATIONS

The FC-757AT and FAS-1-4R Remote Antenna Selector are designed for unbalanced RF feedlines. For antennas that require balanced feed, or for connecting balanced feedlines to this equipment, balun transformers are recommended. Such baluns

of the feedline is open-wire type, the length of coax used should be as short as possible in relation to the open-wire portion, to minimize feedline loss in high SWR conditions.

While the range of SWRs that the FC-757AT is able to match is quite wide, antenna systems that are very far from resonance at the operating frequency may present too high an SWR to permit proper matching with the Tuner. In such cases it is best to retune the antenna itself, or use it only on the bands where it matches easily, installing another antenna for the desired band. If the Tuner is not able to bring the SWR down below 3:1,

Operation under such conditions is not recommended.

The FAS-1-4R is designed to allow remote selection of up to four additional antennas, with only a single feedline and control cable from the FC-757AT to the FAS-1-4R. Once set, the correct antenna for each band is selected automatically whenever the operating band is changed in the Tuner.

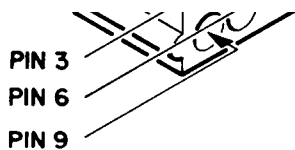
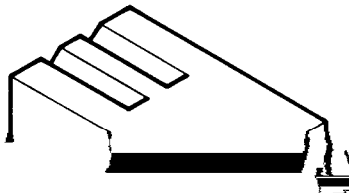

ACC-2

INTERCONNECTIONS

Figures 1 through 4 on the following pages illustrate the interconnections between various models of HF equipment and the FC-757AT, and optional FAS-1-4R. When setting up the station, be sure to install the earth ground connections to

the FT-757GX and FT-980, respectively. Control cable C, for connecting the FT-757GX to the FC-757AT, is supplied with the Tuner. However, the control cable required for connecting the FT-980 ACC-1 jack to the FC-757AT (for automatic power switching and band selection) is optional.

Figures 3 and 4 illustrate the interconnections of the FC-757AT when used with equipment that is not designed to provide power and automatic bandswitching signals for the Tuner. In these cases, supplied DC power cable B is used to connect the Tuner to a separate source of DC (12 to 15V at

may also be used in this way, without the automatic functions.

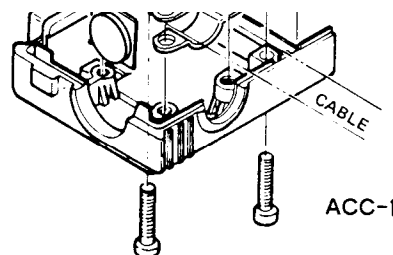
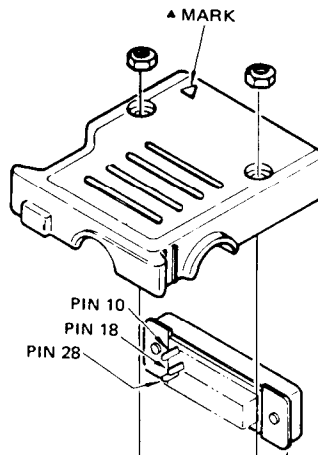
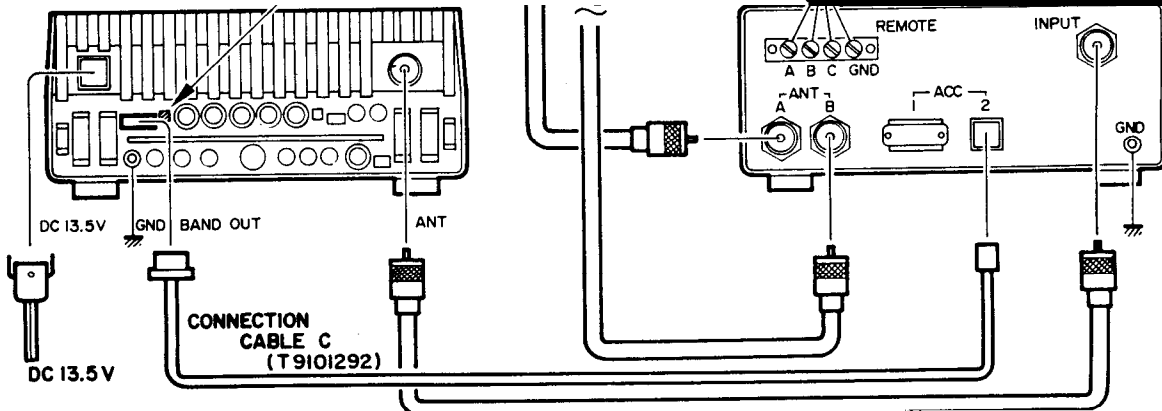
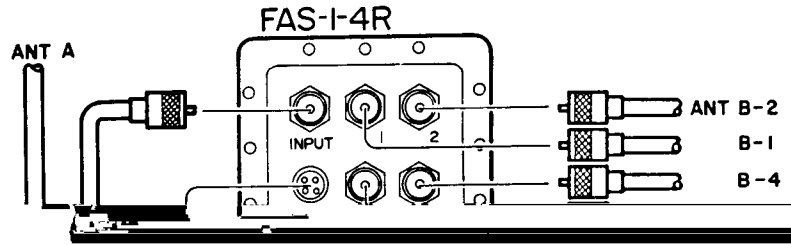

FIGURE 1.
FC-757AT
AND FT-757GX



CONNECTION CABLE A (T9100160A)

FIGURE 2.
FC-757AT
AND FT-980

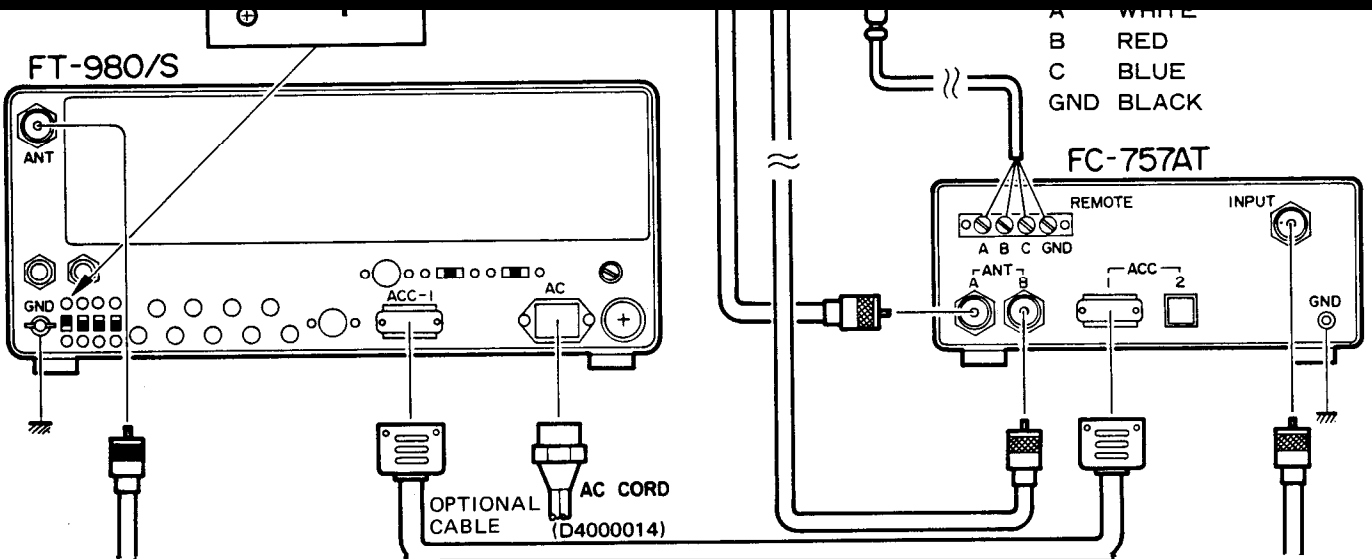
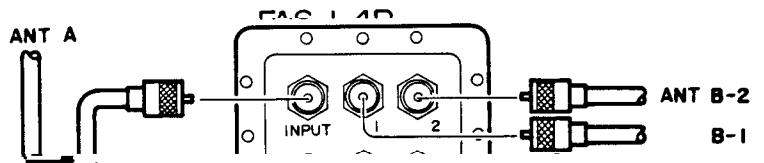
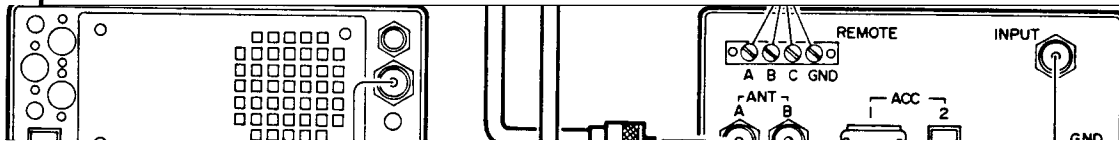

FIGURE 3.

ANT A
FAS-I-4R



CONNECTION CABLE A (T9100160A)

FIGURE 4.
FC-757AT
AND RECEIVER

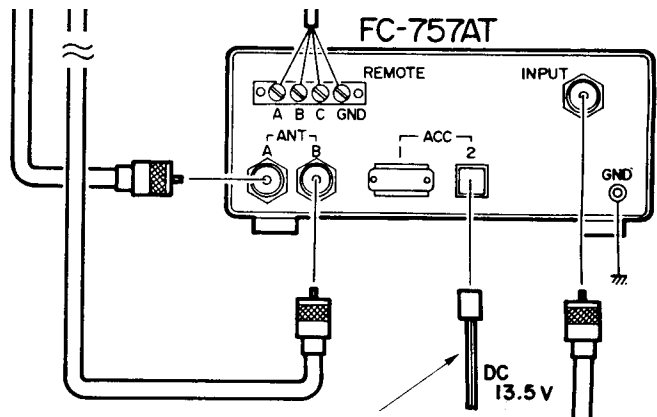
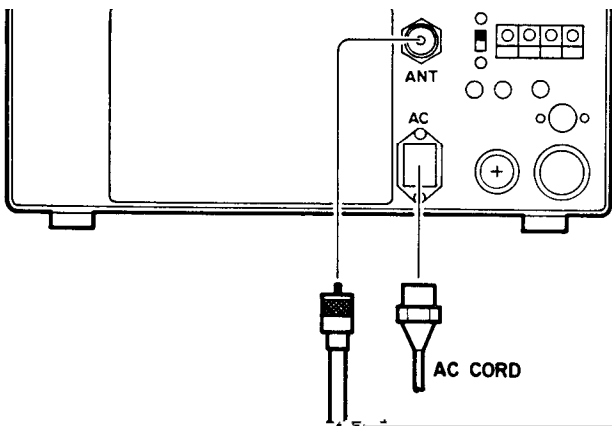
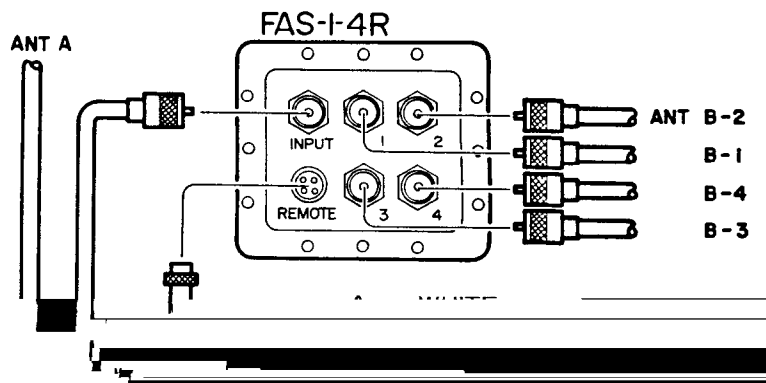

OPERATION

Before switching on power, recheck all interconnections as described on the previous pages. If using the FT-757GX with control cable C connected, depress the LIN AMP button on the rear panel of the transceiver. If using the FT-980 with the optional control cable connected, set the LIN AMP switch on the rear of the transceiver to

button on the Tuner, and then key the transmitter and adjust the TUNE or PLATE and LOAD controls on the transceiver for 100 watts output and a dip in plate current as described in the operating manual for the transceiver. Do not exceed 30 seconds of transmission into the dummy load. If you need more time, let it cool for at least

tions where the FC-757AT is not remotely controlled, it is possible to utilize this feature by connecting the INH line from the Tuner to the TTL-level TX inhibit line of the transceiver, if available. Otherwise, extreme care must be taken at all times to avoid transmitting during band changing (while the WAIT indicator is lit). Also, avoid pressing the DUMMY or THRU switches, or manually changing bands or antennas while transmitting.

When the FC-757AT is connected for control by the transceiver, POWER switching and band selection is automatic as long as the POWER switch on

Auto-tune Matching

Once adjusted, the READY indicator will light, signifying that it is now okay to transmit. Now set the SENS control fully clockwise, and set the 15/150 METER switch to the 150 position (or the 15 position if operating with less than 15 watts). Set up the transceiver to send a CW carrier, and key the transmitter. If necessary, adjust the DRIVE or other power output control so that some transmitter ALC voltage can be observed on the ALC meter of the transceiver.

manually using the DOWN and UP keys on the Tuner, with the currently selected band indicated by the associated LED.

Switch the FC-757AT POWER switch on, and then switch the transceiver on. Tune the transceiver (and Tuner, if not connected for automatic control) to the desired operating band. The Tuner will adjust itself automatically for the frequency and load conditions last encountered on that band, and the WAIT indicator will be lit for about 10 seconds.

transmitting immediately and check the antenna and feedline connections for a short or open circuit. Do not proceed until the cause is located and the fault removed.

Now press the START button while transmitting the carrier, and note that the WAIT indicator lights again. The auto-tune circuit is now functioning, and if you have the SWR/PO switch set to SWR, you will see the auto-tuning seek the point of minimum SWR. As long as the selected antenna is not too far from resonance at the operating frequency, the WAIT indicator will

amplifier circuit, such as the FT-102, the final network in the transceiver must be tuned for a 50-ohm load before matching with the FC-757AT. To do this, press the DUMMY

If the antenna is far from resonance (or if antenna Q is high), and especially if you are using a transceiver that has a broadband solid state power amplifier, the automatic final protection circuitry in the transceiver may interfere with the auto-tune system. This is because the output protection circuitry automatically reduces the power of the transmitter when the SWR is high, and such power reduction may mislead the auto-tune sensors. In this case, rotate the SENS control slightly counterclockwise, and allow the auto-tune system to adjust minimum SWR at the lower SENSitivity setting. When the READY indicator lights, rotate the SENS control to the fully clockwise position, return to receive for a moment, then transmit again. Any residual SWR will then be tuned out, if necessary.

When the SENS control is set fully clockwise, any time that the transmitter is activated and the SWR is about 1.5:1, the auto-tune system will seek to retune the antenna. This will occur if the transmitter is retuned to a different frequency, or if any changes in SWR appear in the antenna (due to repositioning, weather changes, etc.). Therefore, for mobile operation, the auto-tune system must be desensitized once the antenna has been matched. To do this, set the SENS control fully counterclockwise.

Manual Matching

Tuner to match an antenna for receiving only, manual impedance adjustment is possible.

TUNE and LOAD Adjustment Sequence

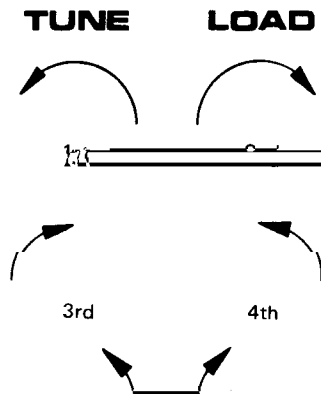

When using a transmitter on the amateur bands, set the SENS control fully counterclockwise to disable the auto-tune system, and set the METER SWR/PO switch to the PO (undepressed) position. Now transmit a carrier while pressing the four TUNE and LOAD buttons (one at a time) while watching the PO meter indication for maximum deflection. When this is obtained, press the METER SWR/PO switch to the SWR position, and make sure that the SWR is below 3:1. Return the transceiver to receive. If the SWR indicated above 3:1, it might be possible to obtain a better match on another band setting. To do this, set the MANUAL button to the depressed position, press the DOWN or UP button, key the transmitter and repeat the adjustment for maximum PO. If the SWR cannot be brought below 3:1 in any band setting or adjustment of the tuner, or if the WARNING indicator is lit, do not use that particular antenna for transmitting at that frequency.

Manual adjustment settings will be stored in memory when changing bands, just like automatic settings.

Receive-Only Matching

The automatic and manual matching techniques described above must not be used for operating frequencies that are outside of the frequency ranges in which the operator is authorized to transmit, since it is necessary to apply power to the antenna in both methods. However, the EC

receiver to an AM station that is relatively free from fading, set the receiver AGC to the fast position, and press the four TUNE and LOAD buttons

(one at a time) to obtain the highest possible signal strength indication on the receiver S-meter.

In some cases, such as when receiving on a frequency far from an amateur band, or using an antenna that is far from resonance, it may not be possible to obtain a good S-meter peak. If this

FAS-1-4R REMOTE ANTENNA SELECTOR

The FAS-1-4R Remote Antenna Selector may be installed at the feedpoints of the antennas providing selection between up to four antennas using only one coaxial feedline and control cable between the FC-757AT and Selector. Heavy duty

FT-980 Users –

When operating on the GEN mode, the Tuner will be automatically set to THRU (bypass) internally, via the control cable, unless the MANUAL button on the FC-757AT is pressed.

Automatic Memory System and Backup

When you have tried the FC-757AT on several bands, it should become obvious that the microprocessor in the Tuner is recalling the previous tuner settings used on each band whenever it is selected. Also, if you are using several different antennas, you will notice that the antenna last selected for each band is also automatically re-selected when returning to that band.

The Tuner settings and selected antenna data are stored in RAM, and retained by a lithium backup battery which is normally switched on at the factory. Current drain is so small that the lithium battery should last at least five years, if left on all the time. However, if it is necessary to store the FC-757AT for a long period of time, the backup system may be switched off by moving the backup switch on the CPU Unit (beneath the top cover) to the right. All information in the memory will thus be cleared. See page 16 for the location of the backup switch.

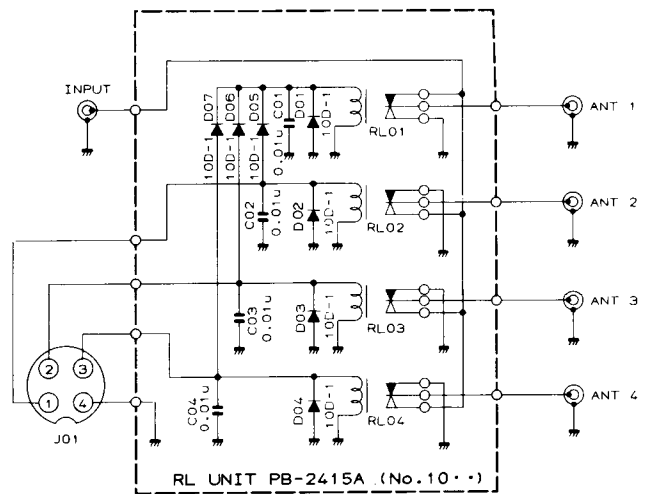

FAS-1-4R Schematic Diagram

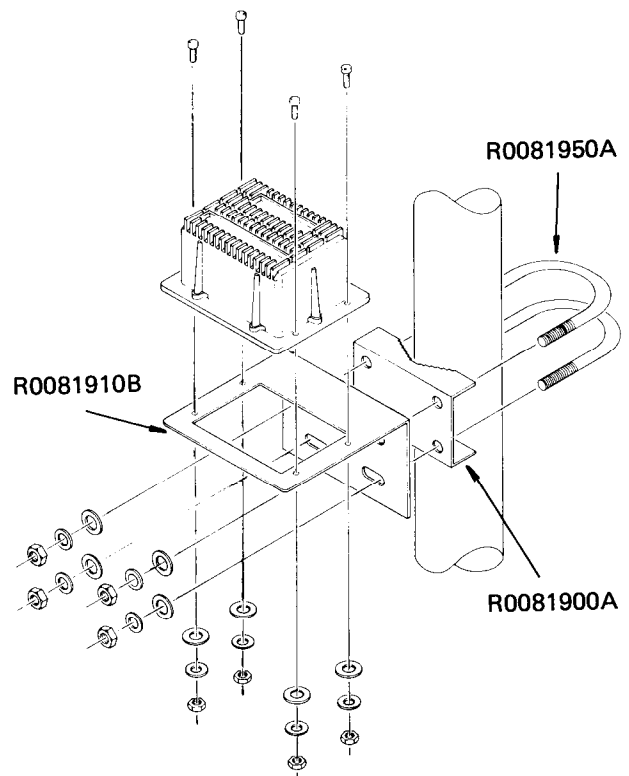

Figure 1

Table 1
CONTROL CABLE CONNECTIONS

| TERMINAL | PLUG PIN NO. |
|----------|--------------|
|----------|--------------|

Installation at Remote Location

1. Bolt the FAS-1-4R to the angle bracket using the four screws, nuts and washers as shown in

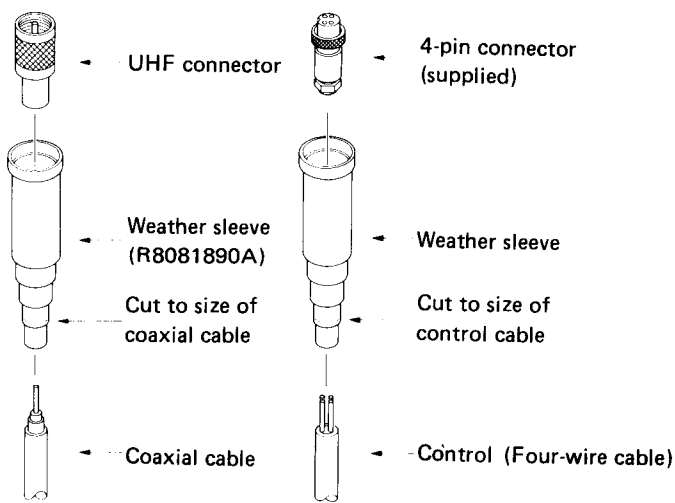

Figure 3

cables and solder the wires to the connectors. The wiring of the control cable is indicated in Table 1.

3. Using the U-bolt and Mast Clamp supplied, mount the FAS-1-4R on the tower or support mast (mast diameter must be 37–64 mm, or different hardware will be required).
4. Mate the connectors, one at a time, with their jacks on the FAS-1-4R, applying sealing compound around each mated fitting after the weather sleeve has been slid over the connector (Figure 4).

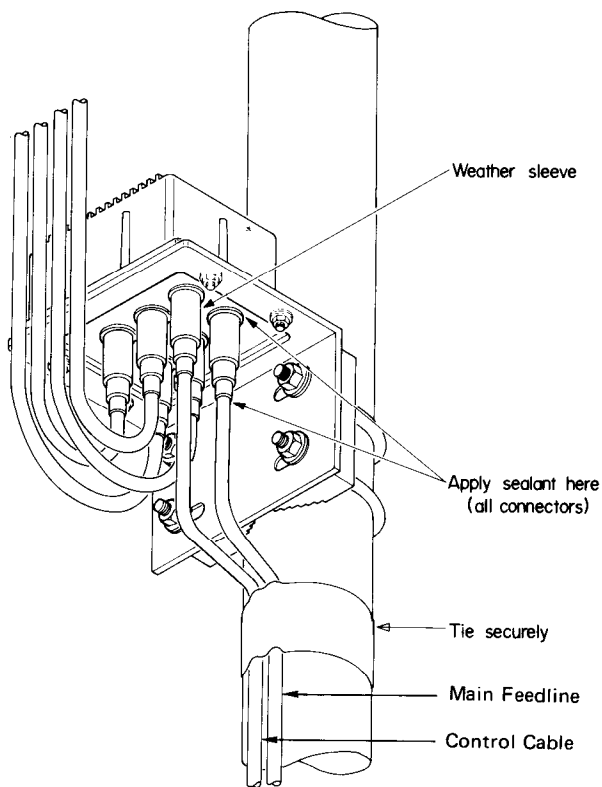

Figure 4

NOTE: The main feedline and control cables should be unbalanced (using baluns, if necessary), and as close as possible to 50-ohms at the intended operating frequencies for best results.

Interconnection with the FC-757AT

Connect the main coaxial feedline from the INPUT jack on the FAS-1-4R to the ANT B terminal on the FC-757AT, and connect the wire ends of the 4-conductor cable from the REMOTE jack on the FAS-1-4R to the REMOTE terminal strip on the FC-757AT, as indicated in Table 1.

ALIGNMENT

The FC-757AT has been carefully aligned at the factory, and with normal use it should not require realignment, although the lithium battery may require replacement after five years. This section describes the procedures used to align the FC-757AT before it leaves the factory, and these should not need to be repeated except in the event of component failure. Should this occur, the FC-757AT should be returned to the dealer from whom it was purchased for repair, at which time the necessary realignments will also be carried out.

Failures caused by unauthorized attempts at alignment are generally not covered by the warranty policy, so any such attempts must be at the customer's own risk.

The following tools and equipment are required for alignment:

One 17-ohm non-reactive dummy load (or three 50-ohm dummy loads connected in parallel)

One 50-ohm non-reactive dummy load

In-line RF wattmeter with 20 and 200W ranges and 5% accuracy at 14 MHz.

1.5 mm hex Allen wrench (for setscrews).

HF transmitter or transceiver capable of 10 and 100W output on the 14 MHz band.

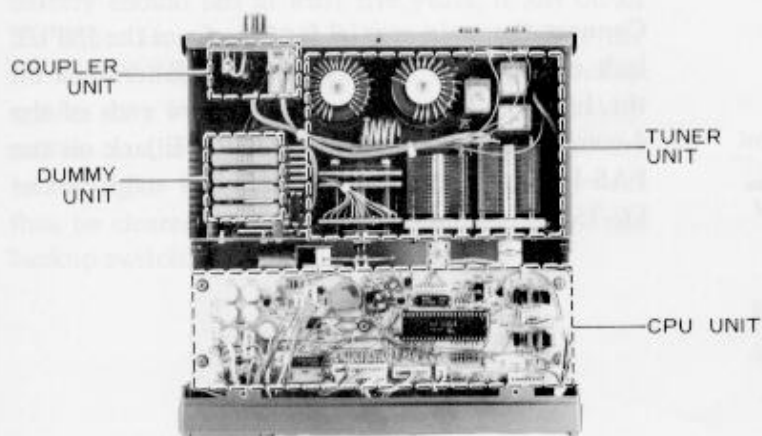
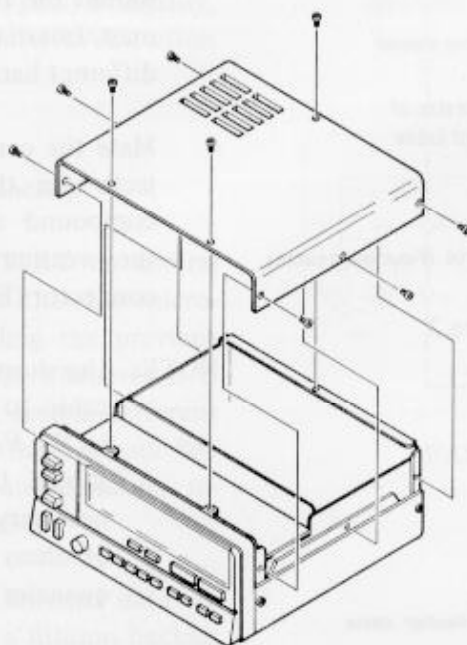

TOP VIEW

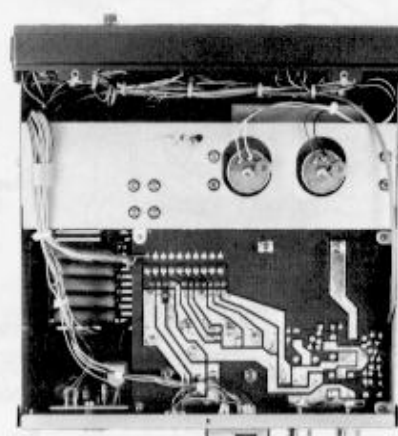

BOTTOM VIEW

CM Coupler Balance

1. Connect the inline wattmeter with 50-ohm dummy load to the ANT A jack, and set the FC-757AT and transceiver to the 14 MHz band. On the FC-757AT, press the ANTENNA A button, and set the THRU switch to the depressed position and the SWR/PO switch to the SWR (depressed) position.
2. Adjust the transmitter to provide 100W steady CW, and then with the PTT line closed, adjust TC₃₀₁ (rear left corner of the chassis) for minimum deflection on the FC-757AT meter.

This procedure must be repeated after the PO Meter and SWR Meter alignments have been performed.

PO Meter Calibration

1. First perform the previous CM Coupler Balance procedure.
2. Set the SWR/PO switch to the PO (undeprassed) position, and with the METER 15/150 switch in the 150 (undeprassed) position, key the transmitter and adjust VR₁₀₄ on the CPU Unit so that the power indications on the internal and external wattmeters coincide at 100 watts.
3. Release the PTT switch and change the scale of the external wattmeter to the lower range. Press the 15/150 button to change the internal wattmeter to the 15-watt range. Reduce the transmitter power to 10 watts, and then key the transmitter and adjust VR₁₀₃ on the CPU Unit so that the power indications on both meters again agree, at 10 watts.

SWR Meter Calibration

The CM Coupler Balance and PO Meter alignment procedures must be performed before proceeding.

1. Note the required settings on the transmitter to produce 10 watts and 100 watts output into 50 ohms, and then replace the 50-ohm load with the 17-ohm dummy load.

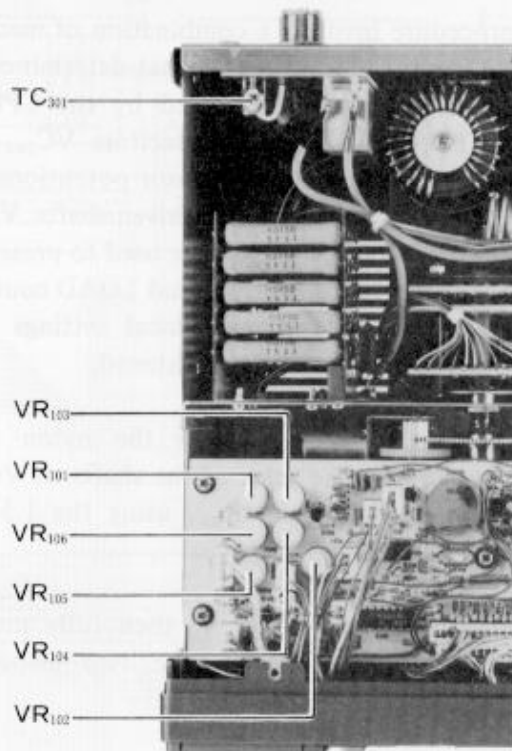

2. Preset VR₁₀₁ on the CPU Unit fully counter-clockwise, and VR₁₀₂ fully clockwise. Set the METER SWR/PO switch to the SWR position, and the 15/150 switch to the 150 position. Set the transmitter controls to the 100-watt positions (determined in the previous step).
3. Key the transmitter and adjust VR₁₀₁ clockwise just to the threshold point where the SWR meter indication begins to decrease. Then adjust VR₁₀₂ so that the meter indicates exactly 3 (-to-1).
4. Now reduce the transmitter power to the 10-watt positions, and check that the SWR meter indication is near 3. If it has changed much, carefully readjust VR₁₀₁ for the threshold point, and VR₁₀₂ for the midscale deflection. Repeat the adjustments at 100 and 10 watts until the indicated SWR, when set to 3 at 100 watts, is between 2 and 3.3 (10 and 25 on the 150W PO scale) at 10 watts. If necessary, increase power to 15 or 20 watts for the low power check.
5. Repeat the CM Coupler Balance procedure.

Variable Capacitor Presetting

This procedure involves a combination of mechanical and electrical adjustments that determines the position-sensing parameters used by the CPU to control TUNE and LOAD capacitors VC_{201} and VC_{202} via the resistance of sensor potentiometers

been made, and all setscrews tightened.

1. Loosen the setscrews in the nylon shaft couplers on the sides of the shafts of VC_{201} , VC_{202} , VR_{01} and VR_{02} , using the 1.5 mm Allen wrench.
2. Set VC_{201} and VC_{202} to their fully meshed positions, and tighten the two associated setscrews on their shafts.
3. Set VR_{01} and VR_{02} both fully counterclock-

the point of minimum capacitance, adjust VR_{105} on the CPU Unit (the motor will move the capacitor automatically).

5. Press the TUNE “◀” button and note the position of VC_{201} when it again stops. If this is not the point of maximum capacitance (fully meshed plates), loosen the shaft coupler and reposition VC_{201} . Then tighten the set-screw again and repeat steps 4 and 5.
6. Follow the same procedure as in steps 4 and 5 to adjust LOAD capacitor VC_{202} , using VR_{106} on the CPU Unit to set the point of minimum capacitance.

Backup Battery Replacement

To determine whether the lithium backup battery needs to be replaced, measure the DC voltage between the top of the battery (exposed side) and ground. If this is 2.0 volts or less, the battery should be replaced. Use a Sony type CR2025-WT1

1. Switch the POWER switch off, and set backup switch S_{101} (as shown below) on the CPU Unit off. Remove the five screws affixing the CPU Unit.
2. Unsolder the terminals of the old battery, and install the new battery in the same manner. Then replace the CPU Unit and its five screws.
3. Set the POWER switch ON first, and then reset S_{101} to the left (on) position. DO NOT

TURN THE BACKUP SWITCH ON FIRST.

CPU UNIT

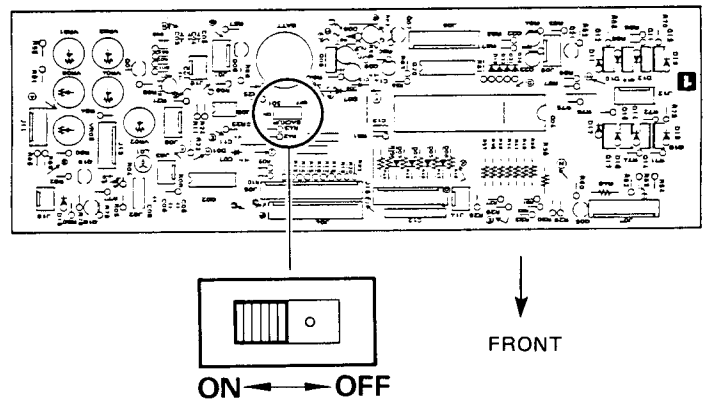

MAIN SCHEMATIC DIAGRAM

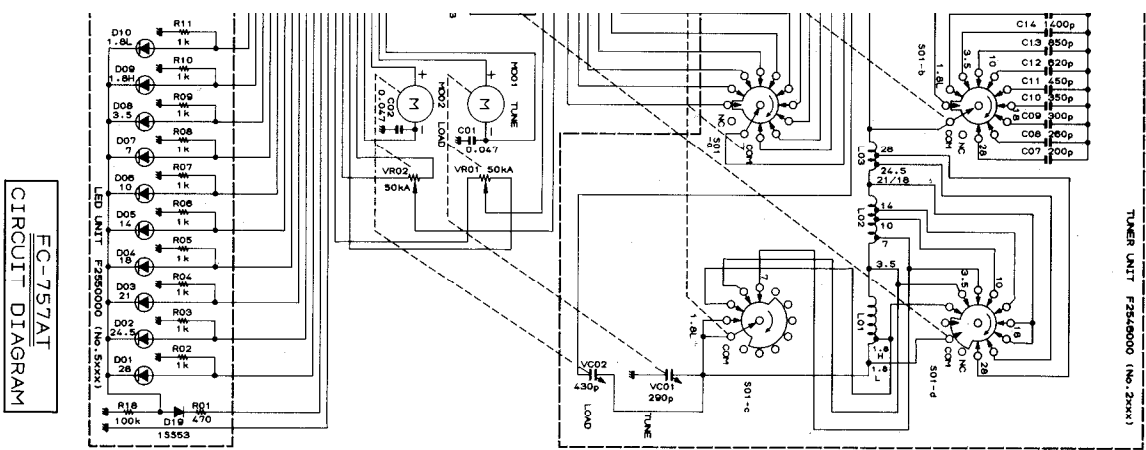
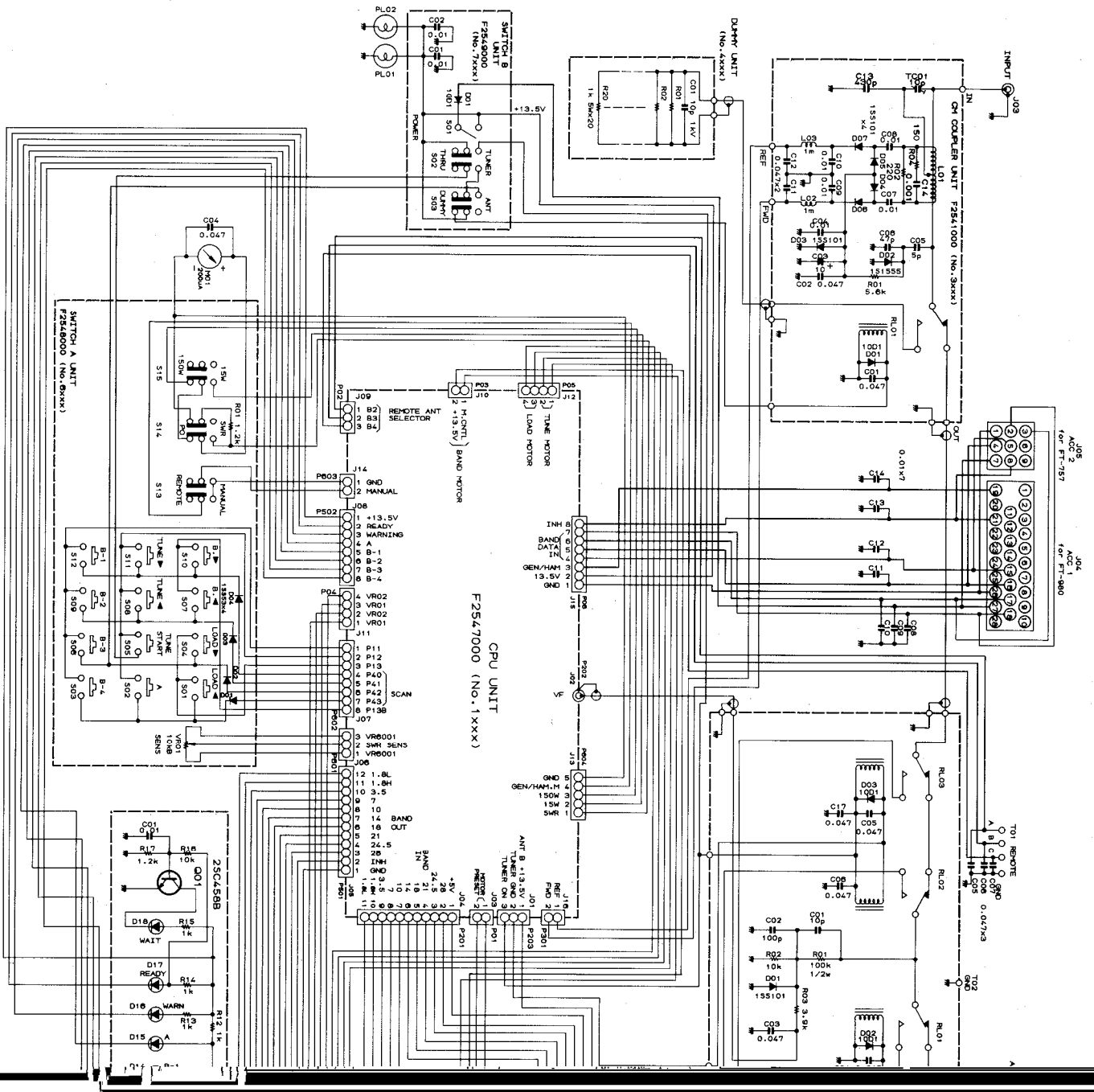

CPU UNIT SCHEMATIC DIAGRAM

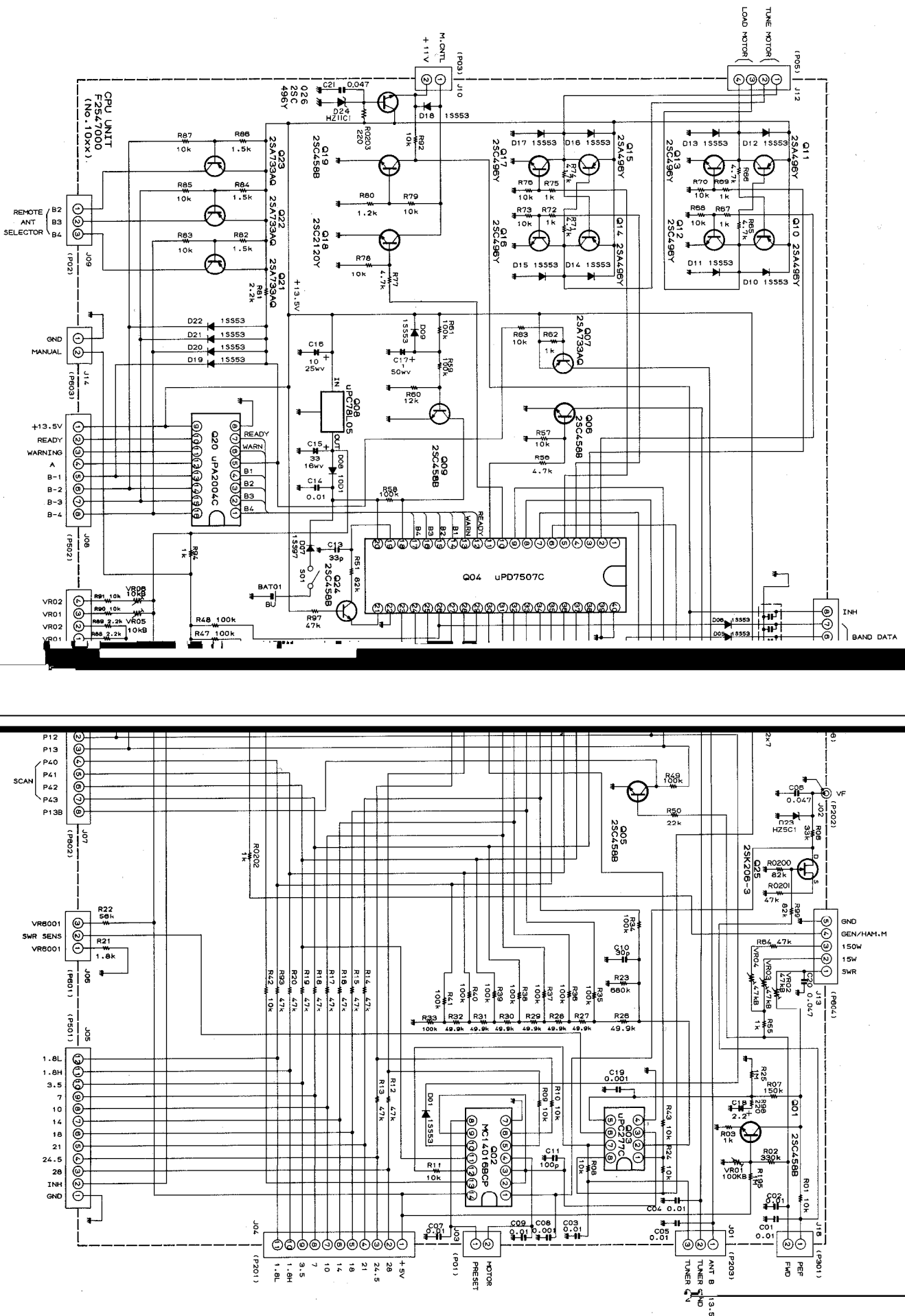

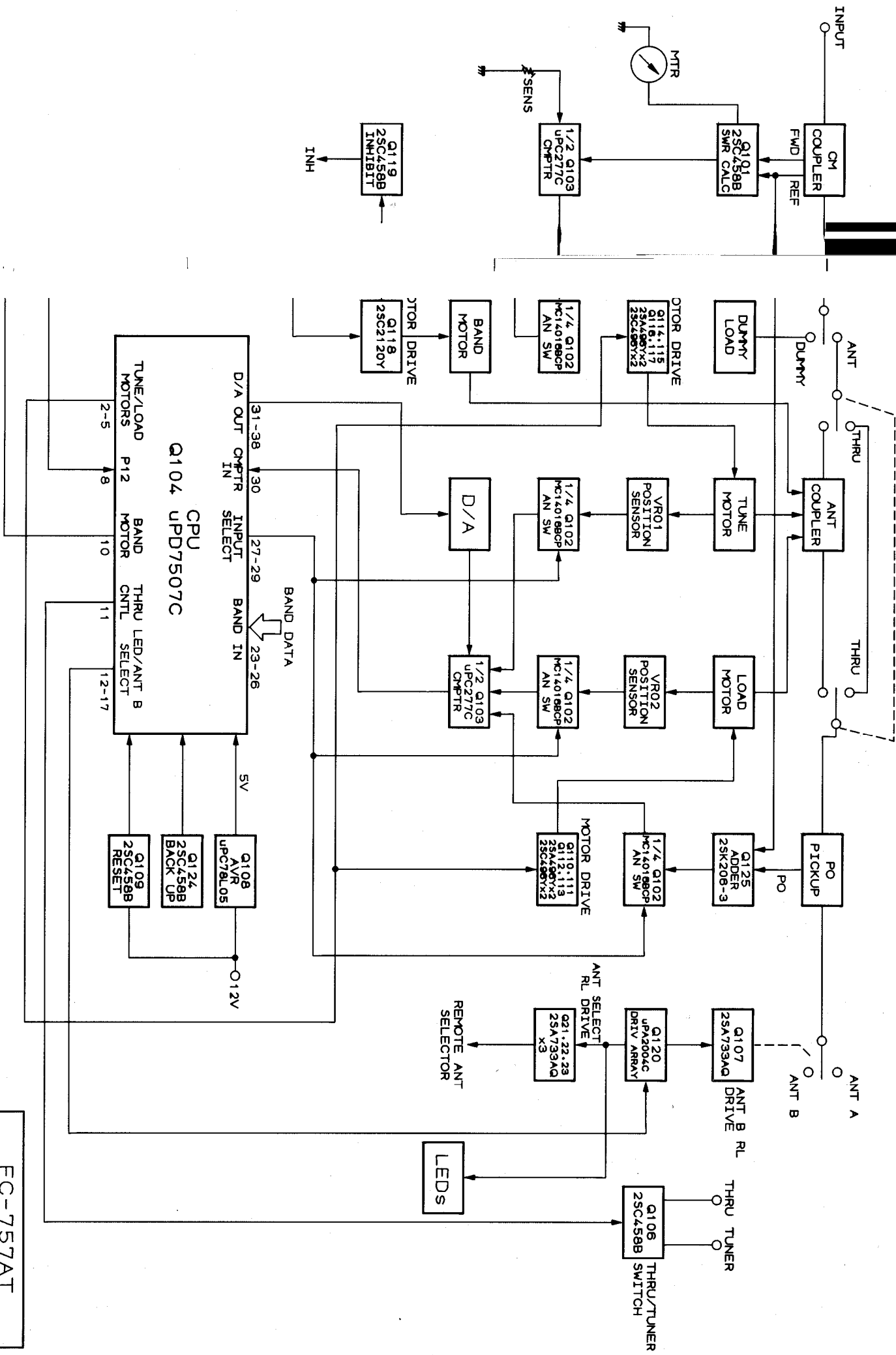

FC-757AT
BLOCK DIAGRAM

PARTS LIST

| MAIN CHASSIS | | | | S4000027 | FOOT (REAR) |
|----------------|-----------|--|--|-----------|--|
| Symbol No. | Part No. | Description | | R3100700 | FOOT (FRONT) |
| | | POTENTIOMETERS | | R0100690 | WIRE STAND |
| VR1,2 | J60800103 | K1611007AC50KA 50kΩA | | | |
| | | | | | |
| | | CAPACITORS | | | |
| C4 | K13179008 | Ceramic disc 50WV F 0.01μF (DD106F103Z50V) | | | |
| C1-7 | K13179009 | " " " " 0.047μF (DD110F473Z50V) | | | |
| | | | | | |
| | | METER | | | CPU UNIT |
| M1 | M0290042 | Y-40 | Q102 | G1090124 | MC14016BCP |
| | | | Q103 | G1090552 | μPC277C |
| | | | Q104 | G1090553 | μPC7507C-Y16 |
| | | METER LAMPS | Q108 | G1090084 | μPC78L05 |
| PL1,2 | Q1000047 | 14V 80mA | Q120 | G1090094 | μPA2004C |
| | S20000006 | COLOR CAP | | | |
| | | | | | ICs |
| | | | QS101 | P3090067 | C844002 |
| | | MOTORS | | | IC SOCKET |
| MO1-3 | M2190004 | MDN-7R1 | | | C844002 |
| | | | Q125 | G3090052 | 2SK206-3 |
| | | | | | FET |
| | | RECEPTACLES | | | TRANSISTORS |
| J1-3 | P1090194 | FM-MR-M2' | Q110,111,114,115 | G3104960Y | 2SA496Y |
| J4 | P1090131 | S-1628A-STA | Q107,121-123 | G3107331Q | 2SA733AQ |
| J5 (with wire) | T9204741 | 1625-09P | Q101,105,106,109, 112,113,116,117, 119,124,126 | G3304960Y | 2SC496Y |
| P1,4,5(") | T9204748A | XHP-2 | | | |
| P2,6(") | T9204740A | XHP-3 | | | |
| P3 (") | T9204744 | XHP-2 | Q118 | G3321200Y | 2SC2120Y |
| | | | | | |
| | | | | | DIODES |
| | | TERMINALS | D101,103-106, 109-122 | G2090027 | Si 1SS53 |
| | Q6000071 | BP-23-4PB | D108 | G2090001 | " 10D1 |
| | Q9000078 | T-10 | D107 | G2090118 | Schottky Barrier 1SS97 |
| | | | D123 | G2090188 | Zener HZ5C1 |
| | | | D124 | G2090251 | " HZ11C1 |
| | | KNOB & BUTTONS | | | RESISTORS |
| | R3101120A | Knob SENS | | | |
| | R3101140 | Push key UP,DOWN | R126-132 | J20249213 | Metallic film 1/4W 49.9kΩ ±1% (ERO25VKF4992) |
| | R3072900 | " button START, ANTENNA, TUNE,LOAD | R133-141 | J20249045 | " " " 100kΩ ±1% (ERO25CKF1003) |
| | R3100820A | " " DUMMY,THRU | R198,0203 | J01245221 | Carbon film 1/4W TJ 220Ω |
| | R3101100A | " " POWER | R103,155,162,167, 169,172,175,194, 0202 | J02245102 | " " " SJ 1kΩ |
| | R3101110 | " " SWR/PO,15/150 | | | |
| | R3101130A | " " MANUAL | | | |
| | | GEARS | R180 | J02245122 | " " " " 1.2kΩ |
| | R9500540 | TUNE,LOAD GEAR ASSY | R182,184,186 | J02245152 | " " " " 1.5kΩ |
| | B3500550 | GEAR | R121 | J02245182 | " " " " 1.8kΩ |
| | S1000006 | SHAFT COUPLER | R181,188,189 | J02245222 | " " " " 2.2kΩ |
| VR1,2 | J6080103 | POTENTIOMETER(SENSOR) | R156,165,166,171, 174,177 | J02245472 | " " " " 4.7kΩ |
| MO1,2 | M2190004 | MOTOR | | | |
| | B4101210 | WORM GEAR | R101, 108-111,124, 142,143,157,163, 168,170,173,176, 178,179,183,185, 187,190-192 | J02245103 | " " " " 10kΩ |
| | R9500570 | BAND GEAR ASSY | | | |
| | B3500560 | GEAR | | | |
| | M2190004 | MOTOR | | | |
| | B4101210 | WORM GEAR | R196 | J01245103 | " " " " TJ 10kΩ |
| | R9101220 | GEAR(Band SW) | R160 | J02245123 | " " " " SJ 12kΩ |
| | | | R150 | J02245223 | " " " " 22kΩ |
| | | | R106 | J02245333 | " " " " 33kΩ |
| | S1000006 | SHAFT COUPLER | | | |

| | | | | | |
|---------------------------|-----------|---|--------------|-----------|--|
| R112-120,164, 193,0201 | J02245473 | Carbon film 1/4W SJ 47kΩ | | | LITHIUM BATTERY |
| | | | BAT101 | Q9000106 | CR-2025 |
| R197 | J01245473 | " " " TJ 47kΩ | | | |
| R122 | J02245563 | " " " SJ 56kΩ | | | |
| R151,199,0200 | J02245823 | " " " " 82kΩ | | | |
| R144-149 | J01245104 | " " " TJ 100kΩ | | | |
| R158,159,161 | J02245104 | " " " SJ 100kΩ | | | |
| R107 | J02245154 | " " " " 150kΩ | | | |
| R152-154 | J02245224 | " " " " 220kΩ | | | |
| R102 | J02245334 | " " " " 330kΩ | Symbol No. | Part No. | Description |
| R123 | J02245684 | " " " " 680kΩ | | F2546000 | Printed Circuit Board |
| R125 | J02245105 | " " " " 1MΩ | | C025460A | PCB with components |
| R195 | J01245105 | " " " TJ 1MΩ | | | |
| | | | | | TUNER UNIT |
| | | POTENTIOMETERS | D201 | G2090223 | Schottky Barrier 1SS101 |
| VR105,106 | J51723103 | H1051A013-10KB 10kΩB | D202,203 | G2090001 | Si 10D1 |
| VR102-104 | J51723473 | H1051A017-47KB 47kΩB | | | |
| VR101 | J51723104 | H1051A019-100KB 100kΩB | | | |
| | | | | | DIODES |
| | | | | | |
| | | | | | RESISTORS |
| | | | R203 | J02245392 | Carbon film 1/4W SJ 3.9kΩ |
| | | | R202 | J02245103 | " " " " 10kΩ |
| | | | R201 | J02245104 | " " " " 100kΩ |
| | | | | | |
| | | CAPACITORS | | | |
| C110 | K00179007 | Ceramic disc 50WV SL 30pF (DD104SL300J50V) | | | |
| C113 | K02175330 | " " " CH 33pF (DD105CH330J50V) | | | |
| C111 | K00175101 | " " " SL 100pF (DD105SL101J50V) | C203-206,217 | K13179009 | Ceramic disc 50WV F 0.047μF (DD110F473Z50V) |
| C108,119 | K10176102 | " " " B 0.001μF (DD104B102K50V) | C201 | K30275100 | Dipped Mica 500WV 10pF (LCQ11100J5) |
| C101-105,107, 109,114 | K13179008 | " " " F 0.01μF (DD106F103Z50V) | C202 | K30275101 | " " " 100pF (LCQ12101J5) |
| C106,120,121 | K13179009 | " " " " 0.047μF (DD110F473Z50V) | C207 | K30309026 | " " 1KWV 200pF (DML2 201J10) |
| C117 | K40179013 | Electrolytic 50WV 1μF (50RE1) | C208 | K30309027 | " " " 260pF (DML2 261J10) |
| C118 | K40179009 | " " 2.2μF (50RE2R2) | C209 | K30309011 | " " " 300pF (DML2 301J10) |
| C116 | K40149008 | " 25WV 10μF (25RE10) | C210 | K30309028 | " " " 350pF (DML2 351J10) |
| C115 | K40129008 | " 16WV 33μF (16RE33) | C211 | K30309029 | " " " 450pF (DML2 451J10) |
| | | | C212 | K30309030 | " " " 620pF (DML2 621J10) |
| | | | | | |
| | | BLOCK CAPACITOR | C213 | K30309031 | " " " 850pF (DML2 851J10) |
| C112 | K80000005 | 50WV 0.0082μF x 7 (B8ZC0111-32N) | C214 | K30309032 | " " " 1400pF (DML2 142J10) |
| | | | | | |
| | | | C215 | K30309033 | " " " 2300pF (DML2 232J10) |
| | | | | | |
| | | | C216 | K30309034 | " " " 2600pF (DML2 262J10) |
| | | | | | |
| | | | | | |
| | | SWITCH | | | |
| S101 | N6090037 | SSS-312049 | | | VARIABLE CAPACITOR |
| | | | VC201 | K90000041 | YB-290-SL8 (TUNE) |
| | | | VC202 | K90000042 | YB-430-SL8 (LOAD) |
| | | | | | |
| | | CONNECTORS | | | |
| J103,110,114,116 | P0090191 | B2B-XH-A | | | |
| J101,106,109 | P0090192 | B3B-XH-A | | | INDUCTORS |
| J111,112 | P0090193 | B4B-XH-A | L201 | L0021391 | |
| J113 | P0090194 | B5B-XH-A | L202 | L0021392 | |
| J107,108,115 | P0090197 | B8B-XH-A | L203 | L0021393A | |
| J104 | P0090200 | B11B-XH-A | | | |
| J105 | P0090201 | B12B-XH-A | | | |
| J102 | P1090255 | TMP-JA | | | |

| RELAYS | | | RELAY | | |
|--------------------------|-----------|---|----------------------|-----------|---|
| RL201-203 | M1190026 | | RL301 | M1190026 | MR-31 12V |
| SWITCH | | | | | |
| S201 | N0050069A | SR32HP3-3-10 | | | |
| DUMMY LOAD UNIT | | | | | |
| PLUGS | | | Symbol No. | Part No. | Description |
| P201 | T9204746 | XHP-11 | RESISTORS | | |
| P202 | T9311801 | TMP | R401-420 | J22375102 | Metallic film 5W 1k Ω (RSF-5BJ) |
| P203 | T9204747 | XHP-3 | | | |
| TERMINAL | | | CAPACITOR | | |
| | Q5000011 | Wrapping C | C401 | K31306100 | Molded Mica 1KWV 10pF (CML1 100K10) |
| | Q5000036 | TP-G | | | |
| CM COUPLER UNIT | | | LED UNIT | | |
| Symbol No. | Part No. | Description | Symbol No. | Part No. | Description |
| | F2541000 | Printed Circuit Board | | F2550000 | Printed Circuit Board |
| | C025410A | PCB with components | | C025500A | PCB with components |
| DIODES | | | TRANSISTOR | | |
| D301 | G2090001 | Si 10D1 | Q501 | G3304580C | 2SC458C |
| D302 | G2015550 | " 1S1555 | | | |
| D303-307 | G2090223 | Schottky Barrier 1SS101 | | | |
| RESISTORS | | | D501-510,515, 517 | G2090267 | LED SG238D |
| R304 | J01245151 | Carbon film 1/4W TJ 150 Ω | D511-513,514, 518 | G2090268 | " SY438D |
| R302 | J02245221 | " " " SJ 220 Ω | D516 | G2090269 | " SR538D |
| R301 | J02245562 | " " " " 5.6k Ω | D519 | G2090027 | Si 1SS53 |
| CAPACITORS | | | RESISTORS | | |
| C305 | K02279002 | Ceramic disc 500WV CH 5pF (ECC-D2H050DC) | R501 | J02245471 | Carbon film 1/4W SJ 470 Ω |
| C306 | K00175470 | " " 50WV SL 47pF (DD104SL470J50V) | R502-515 | J02245102 | " " " " 1k Ω |
| C314 | K10176102 | " " " B 0.001 μ F (DD104B102K50V) | R517 | J02245122 | " " " " 1.2k Ω |
| C304,307-310 | K13179008 | " " " F 0.01 μ F (DD106F103Z50V) | R516 | J02245103 | " " " " 10k Ω |
| C301,302,311,312 | K13179009 | " " " " 0.047 μ F (DD110F473Z50V) | R518 | J02245104 | " " " " 100k Ω |
| C313 | K30275431 | Dipped Mica 500WV 430pF (LCQ18431J5) | SWITCH A UNIT | | |
| C303 | K40169012 | Electrolytic 35WV 10 μ F (35RE10) | Symbol No. | Part No. | Description |
| TRIMMER CAPACITOR | | | | F2548000 | Printed Circuit Board |
| TC301 | K91000019 | ECV-12W10x40 10pF | | C025480A | PCB with components |
| INDUCTORS | | | D601-604 | G2090027 | DIODES Si 1SS53 |
| L301 | L0021347 | | | | RESISTOR |
| L302,303 | L1190017 | FL5H102K 1mH | R601 | J01245122 | Carbon film 1/4W TJ 1.2k Ω |

| | | | | | |
|----------------------|-----------------|-----------------------|-------|--------|--|
| | | POTENTIOMETER | | | |
| VR601 | J60800102 | K121L0Z04-10KB | 10kΩB | | |
| | | | | | |
| | | SWITCHES | | | |
| S601-612 | N4090049 | KHC10901 | | | |
| S613-615 | N4090085 | SPH2 | | | |
| | | | | | |
| | | | | | |
| | | | | | |
| SWITCH B UNIT | | | | | |
| Symbol No. | Part No. | Description | | | |
| | F2549000A | Printed Circuit Board | | | |
| | C025490A | PCB with components | | | |
| | | | | | |
| | | | | | |
| | | | | | |
| | | DIODE | | | |
| D701 | G2090001 | Si | 10D1 | | |
| | | | | | |
| | | CAPACITORS | | | |
| C701,702 | K13179008 | Ceramic disc | 50WV | 0.01μF | |
| | | (DD106F103Z50V) | | | |
| | | | | | |
| | | SWITCHES | | | |
| S701 | N4090087 | SDW1P | | | |
| S702,703 | N4090086 | SPH1 | | | |
| | | | | | |
| | | | | | |
| | | | | | |
| ACCESSORIES | | | | | |
| Symbol No. | Part No. | Description | | | |
| | T9100160A | Connection Cable A | | | |
| | T9015099 | Connection Cable B | | | |
| | T9101292 | Connection Cable C | | | |
| | | | | | |
| | | | | | |
| | | | | | |
| | | | | | |
| | | | | | |
| | | | | | |
| | | | | | |
| | | | | | |
| | | | | | |
| | | | | | |
| | | | | | |
| | | | | | |
| | | | | | |
| | | | | | |
| | | | | | |
| | | | | | |
| | | | | | |
| | | | | | |
| | | | | | |
| | | | | | |
| | | | | | |
| | | | | | |

